



ITT Enidine Adjustable Hydraulic Series shock absorbers offer the most flexible solutions to energy absorption application requirements when input parameters vary or are not clearly defined.

ITT Enidine's **New ECO OEM Series** adjustable hydraulic shock absorbers are an expansion of our previously released ECO Series product line. These adjustable shock absorbers provide maximum flexibility in a RoHS compliant package. By simply turning an adjustment knob, the damping force can be changed to accommodate a wide range of conditions. ITT Enidine offers the broadest range of adjustable shock absorbers and mounting accessories in the marketplace today.

The ITT Enidine **OEMXT Series** provides a low profile adjustment knob offered in imperial or metric thread configurations with stroke lengths of 25 to 150 mm for drop-in competitive interchange. **Low Range (LROEMXT) Series** products are also available to control velocities as low as 0,08 m/s and propelling forces as high as 17 790 N OEMXT and OEM Large Series shock absorbers are fully field repairable.

**Features and Benefits**

- **Adjustable design lets you "fine-tune"** your desired damping and lock the numbered adjustment setting.
- **Internal orifice design** provides deceleration with the most efficient damping characteristics, resulting in the lowest reaction forces in the industry.
- **Threaded cylinders provide mounting flexibility** and increase surface area for improved heat dissipation.
- **Operational parameters can be expanded** through the use of Enidine's Low Range and High Performance products.
- **Custom orificed non-adjustable units (CBOEM)** can be engineered to meet specific application requirements or **emergency impact only requirements.**
- **Special materials and finishes** can be designed to meet specific customer requirements.
  - Optional fluids and seal packages can expand the standard operating temperature range from (-10°C to 80°C) to (-30°C to 100°C).
  - Food grade options available
- **ISO quality standards** result in reliable, long-life operation.
- **Fully field repairable units are available** in mid-bore and larger bore product ranges.

**Added New Features for the ECO OEM Series**

- **Environmentally friendly materials:**
  - ROHS Compliant materials
  - Bio-degradable hydraulic oil
  - Recyclable packaging materials
- **Introducing our new Enicote II surface finish:**
  - ROHS Compliant
  - Rated at 350 hours salt spray corrosion protection
- **Jam Nut included** with every shock absorber.
- **Wrench flats** promote ease of mounting
- **Capability to mount into pressure chambers**
- **Integrated positive stopping capabilities** up to 7 bar.

### ITT Enidine Adjustable Single Orifice Shock Absorbers

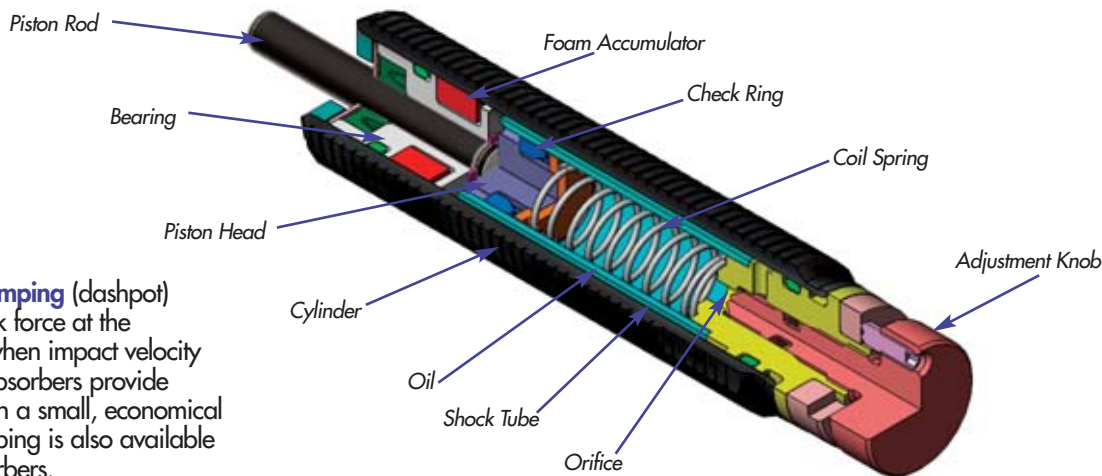
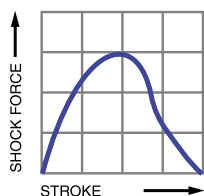

**Constant orifice area damping** (dashpot) provides the largest shock force at the beginning of the stroke when impact velocity is highest. These shock absorbers provide high-energy absorption in a small, economical design. This type of damping is also available in adjustable shock absorbers.

The damping force of an ITT Enidine single orifice shock absorber can be changed by turning the adjustment knob. Maximum damping force is achieved by turning the adjustment knob to eight (8), while minimum damping force is achieved by turning the adjustment knob to zero (0). Turning the adjustment knob causes the adjustment ball to increase or decrease the clearance (orifice area) between the ball and its seat, depending on rotation direction.

The internal structure of an adjustable single orifice shock absorber is shown above. When force is applied to the piston rod, the check ball is seated and the valve remains closed.

Oil is forced out of the high pressure shock tube chamber through the orifice, creating internal pressure allowing smooth, controlled deceleration of the moving load. When the load is removed, the compressed coil spring moves to reposition the piston head, the check ball unseats, opening the valve that permits rapid piston rod return to the original extended position. The closed cellular foam accumulator compensates for fluid displaced by the piston rod during compression and extension. Without the fluid displacement volume provided by the foam accumulator, the closed system would be hydraulically locked.

### ITT Enidine Adjustable Multiple Orifice Shock Absorbers

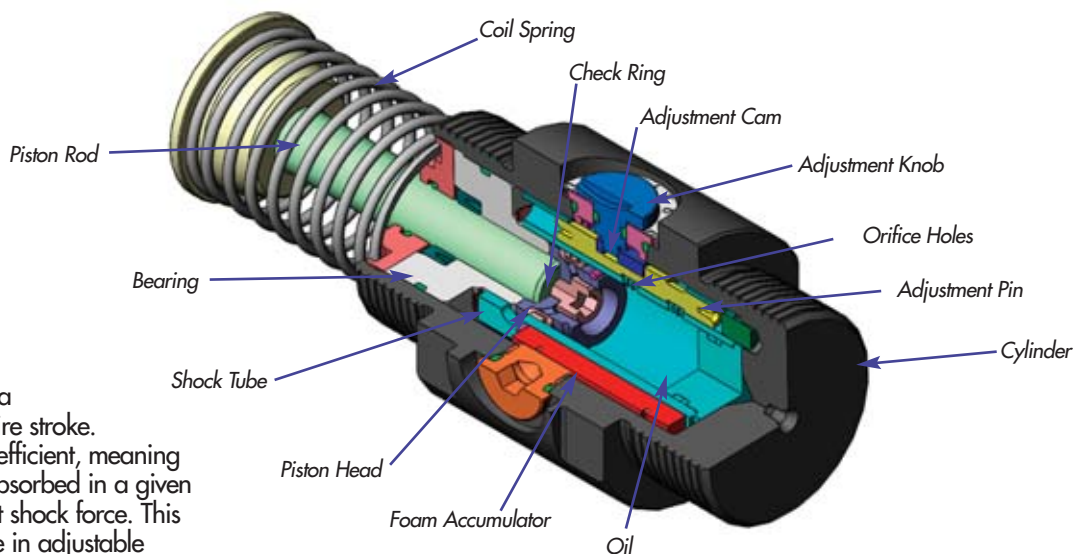
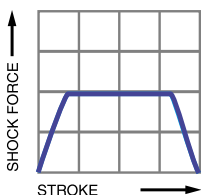

**Conventional damping** allows linear deceleration by providing a constant shock force over the entire stroke. This standard design is the most efficient, meaning it allows the most energy to be absorbed in a given stroke, while providing the lowest shock force. This type of damping is also available in adjustable shock absorbers.

The adjustable multiple orifice shock absorber is similar to the principles described earlier. The check ring replaces the check ball and the adjustment feature uses an adjustment pin instead of an adjustment ball. The damping force of the shock absorber can be changed by turning the adjustment knob. Maximum damping force is achieved by turning the adjustment knob to eight (8), while minimum damping force is achieved by turning the adjustment knob to zero (0).

Turning the adjustment knob rotates the adjustment cam within the shock absorber. The cam, in turn, moves the adjustment pin in the shock tube, closing or opening the orifice holes. By closing the orifice holes, the total orifice area of the shock absorber is reduced, thus increasing the damping force of the shock absorber. The adjustable shock absorber enables the user to change the damping force of the unit, should input conditions change, while still maintaining a conventional-type damping curve. Low velocity range (LR) series configurations are available for controlling velocities that fall below the standard adjustable range.

# Adjustable Series Hydraulic Shock Absorbers

## ECO OEM Small Bore Series

ECO OEM 0.1M → ECO (LR)OEM 1.0M Series

Technical Data

### Standard

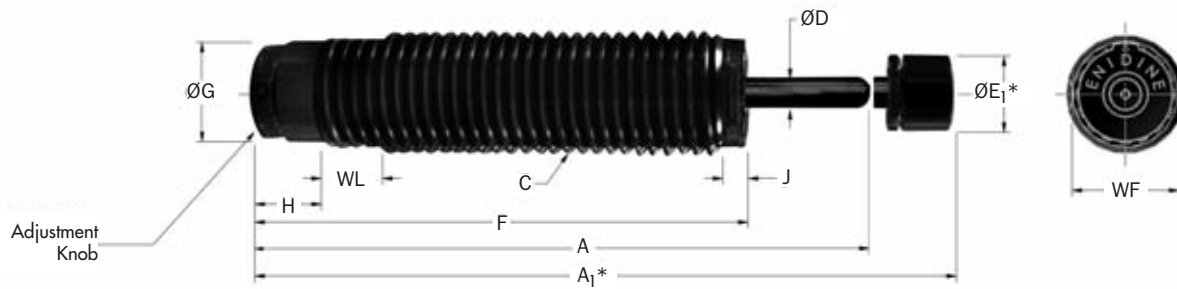

\*Note: A<sub>1</sub> and E<sub>1</sub> apply to button models. One Hex Jam Nut included with every shock absorber.

Catalog No./ Model	(S) Stroke mm	Optimal Velocity Range m/s	E <sub>T</sub> Max. Nm/c	E <sub>T</sub> C Max. Nm/hr	F <sub>p</sub> Max. Reaction Force N	Nominal Coil Spring Force		F <sub>D</sub> Max. Propelling Force N	Mass g
						Extended N	Compressed N		
ECO OEM .1M (B)	7,0	0,3-3,30	6,0	12 400	1 220	2,2	4,5	350	28
ECO OEM .15M (B)	10,0	0,3-3,30	6,0	19 000	890	3,5	7,5	350	56
ECO OEM .25M (B)	10,0	0,3-3,30	6,0	20 000	890	3,5	7,5	350	56
ECO LROEM .25M (B)	10,0	0,08-1,30	6,0	20 000	890	3,5	7,5	440	56
ECO OEM .35M (B)	12,0	0,3-3,30	17,0	34 000	2 000	4,5	9,8	530	85
ECO LROEM .35M (B)	12,0	0,08-1,30	17,0	34 000	2 000	4,5	9,8	890	85
ECO OEM .5M (B)	12,7	0,3-4,50	28,0	32 000	3 500	5,8	12,4	670	141
ECO LROEM .5M (B)	12,7	0,08-1,30	28,0	32 000	3 500	8,9	17,0	1 120	141
ECO OEM 1.0M (B)	25,0	0,3-3,30	74,0	70 000	4 400	13,0	27,0	1 330	285
ECO OEM 1.0MF (B)	25,0	0,3-3,30	74,0	70 000	4 400	13,0	27,0	1 330	285
ECO LROEM 1.0M (B)	25,0	0,08-1,30	74,0	70 000	4 400	13,0	27,0	2 016	285
ECO LROEM 1.0MF (B)	25,0	0,08-1,30	74,0	70 000	4 400	13,0	27,0	2 016	285

Catalog No./ Model	A mm	A <sub>1</sub> mm	C mm	D mm	E <sub>1</sub> mm	F mm	G mm	H mm	J mm	WF mm	WL mm
ECO OEM 0.1M (B)	57,0	67,0	M10 x 1.0	3,0	8,6	49,4	8,6	10,2	–	–	–
ECO OEM 0.15M (B)	81,8	91,7	M12 x 1.0	3,3	8,6	71,4	10,9	14,2	–	11,0	9,7
ECO (LR)OEM .25M (B)	81,8	91,2	M14 x 1.5	3,3	11,2	71,4	10,9	14,2	–	12,0	12,7
ECO (LR)OEM .35M (B)	100,6	110,7	M16 x 1.5	4,0	11,2	87,4	11,2	14,5	0,5	14,0	12,7
ECO (LR)OEM .5M (B)	98,6	110,5	M20 x 1.5	4,8	12,7	84,1	16,0	17,0	–	18,0	12,7
ECO (LR)OEM 1.0M (B)	130,0	142,7	M27 x 3.0	6,4	15,7	104,0	22,0	14,0	4,6	23,0	12,7
ECO (LR)OEM 1.0MF (B)	130,0	142,7	M25 x 1.5	6,4	15,7	104,0	22,0	14,0	4,6	23,0	12,7

- Notes: 1. All shock absorbers will function satisfactorily at 5% of their maximum rated energy per cycle. If less than 5%, a smaller model should be specified.  
 2. For mounting accessories, see pages 22-23.  
 3. (B) indicates button model of shock absorber. Buttons cannot be added to non-button models or removed from button models ECO OEM .1M to ECO OEM 1.0M.

# Adjustable Series Hydraulic Shock Absorbers

## ECO OEM Small Bore Series

ECO OEM 0.1M → ECO (LR)OEM 1.0M Series

Accessories

### Jam Nut (JN)

\*Note: One Hex Jam Nut included with every shock absorber.

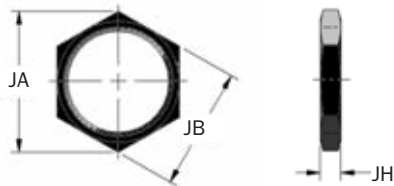

Catalog No./ Model	Part Number	Model Ref	JA mm	JB mm	JH mm	Mass g
JN M10 x 1	J223840167	ECO OEM 0.1M (B)	15,0	13,0	3,2	2
JN M12 x 1	J223841035	ECO OEM .15M (B)	17,0	15,0	4,0	2
JN M14 x 1.5	J223842165	ECO (LR)OEM .25M (B)	19,7	17,0	4,0	3
JN M16 x 1.5	J224055035	ECO (LR)OEM .35M (B)	20,0	19,0	6,0	5
JN M20 x 1.5	J223844035	ECO (LR)OEM .5M (B)	27,7	24,0	4,6	9
JN M27 x 3	J124059034	ECO (LR)OEM 1.0M (B)	37,0	32,0	4,6	15
JN M25 x 1.5	J223846035	ECO (LR)OEM 1.0MF (B)	37,0	32,0	4,6	15

### Stop Collar (SC)

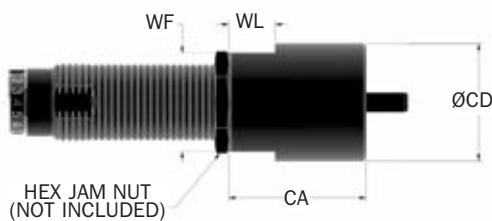

Catalog No./ Model	Part Number	Model Ref	CA mm	CD mm	WF mm	WL mm	Mass g
△ SC M10 x 1	M923840171	ECO OEM 0.1M (B)	19,0	14,0	–	–	11
△ SC M12 x 1	M923841058	ECO OEM 0.15M (B)	19,0	16,0	14,0	9,0	14
△ SC M14 x 1.5	M923842171	ECO (LR)OEM .25M (B)	25,4	19,0	19,0	12,0	28
△ SC M16 x 1.5	M924055199	ECO (LR)OEM .35M (B)	25,4	19,0	–	–	28
△ SC M20 x 1.5	M924057058	ECO (LR)OEM .5M (B)	38,0	25,4	22,0	12,0	63
△ SC M27 x 3	M923846170	ECO (LR)OEM 1.0M (B)	50,8	38,0	32,0	15,0	215
△ SC M25 x 1.5	M923846171	ECO (LR)OEM 1.0MF (B)	50,8	38,0	32,0	15,0	215

Notes: 1. \*Do not use with urethane striker cap.  
2. △ = Non-standard lead time items, contact ITT Enidine.

### Universal Retaining Flange (Small Bore) (UF)

UF M10 x 1 → UF M16 x 1,5

UF M20 x 1,5 → UF M27 x 3

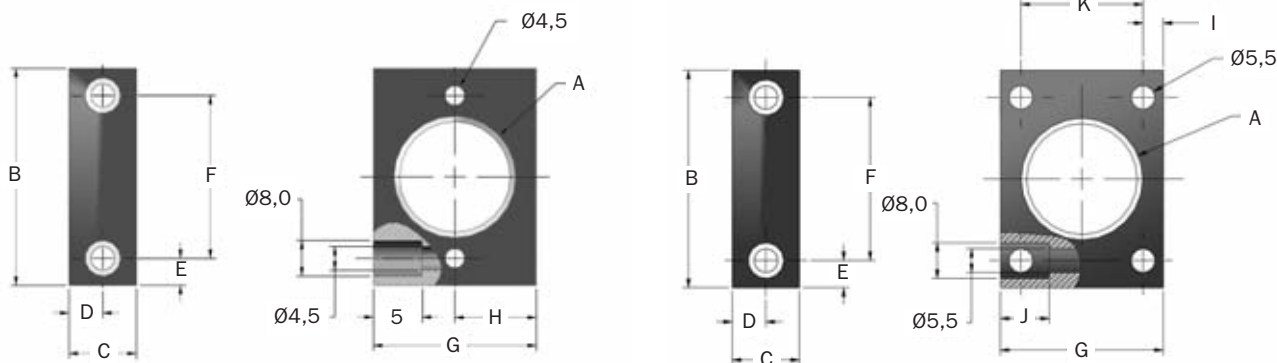

Catalog No./ Model	Part Number	Model Ref	A mm	B mm	C mm	D mm	E mm	F mm	G mm	H mm	I mm	J mm	K mm
△ UF M10 x 1	U16363189	ECO OEM 0.1M (B)	M10 x 1	38,0	12,0	6,0	6,0	25,5	25,0	12,5	–	5	–
△ UF M12 x 1	U15588189	ECO OEM .15M (B)	M12 x 1	38,0	12,0	6,0	6,0	25,5	25,0	12,5	–	5	–
△ UF M14 x 1.5	U13935143	ECO (LR)OEM .25M (B)	M14 x 1,5	45,0	16,0	8,0	5,0	35,0	30,0	15,0	–	5	–
△ UF M16 x 1.5	U19018143	ECO (LR)OEM .35M (B)	M16 x 1,5	45,0	16,0	8,0	5,0	35,0	30,0	15,0	–	–	–
△ UF M20 x 1.5	U12646143	ECO (LR)OEM .5M (B)	M20 x 1,5	48,0	16,0	8,0	6,5	35,0	35,0	–	4,75	11,4	25,5
△ UF M25 x 1.5	U13004143	ECO (LR)OEM 1.0MF (B)	M25 x 1,5	48,0	16,0	8,0	6,5	35,0	35,0	–	4,75	11,4	25,5
△ UF M27 x 3	U12587143	ECO (LR)OEM 1.0M (B)	M27 X 3	48,0	16,0	8,0	6,5	35,0	35,0	–	4,75	11,4	25,5

Notes: 1. △ = Non-standard lead time items, contact ITT Enidine.  
2. All dimensions in millimeters

# Adjustable Series Hydraulic Shock Absorbers

## ECO OEM Small Bore Series

ECO OEM 0.1M → ECO OEM 1.0M Series

### Side Load Adaptor (SLA)

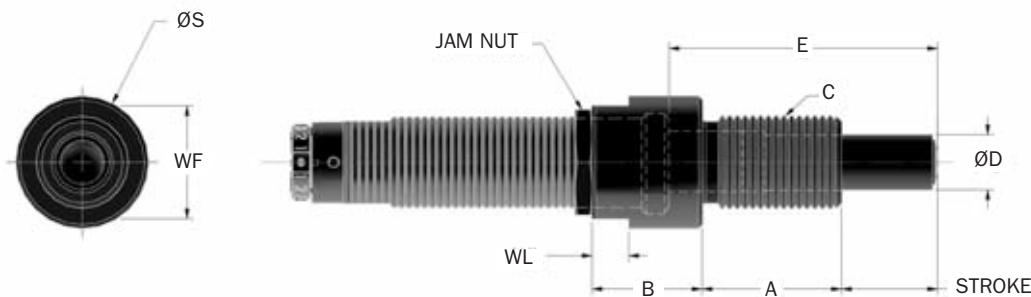

Catalog No./Model	Part Number	Model Ref	Stroke mm	A mm	B mm	C mm	D mm	E mm	S mm	WF mm	WL mm
SLA 10MF	SLA 33457	ECO OEM 0.1M	6,4	12	11	M10 x 1	5	21,9	13	11	4,0
SLA 12MF	SLA 33299	ECO OEM .15M	10,0	18	14	M12 x 1	6	32,4	16	13	7,0
△ SLA 14MC	SLA 34756	ECO (LR)OEM .25M	10,0	18	16	M14 x 1,5	8	34,3	18	15	7,0
SLA 16 MC	SLA 34757	ECO (LR)OEM .35M	12,7	20	16	M16 x 1	8	39,2	20	17	7,0
SLA 20 MC	SLA 33262	ECO (LR)OEM .5M	12,7	24	14	M20 x 1,5	11	41,5	25	22	7,0
SLA 25 MF	SLA 33263	ECO (LR)OEM 1.0MF	25,0	38	30	M25 x 1,5	15	73,2	36	32	10,0
SLA 27 MC	SLA 33296	ECO (LR)OEM 1.0M	25,0	38	30	M27 x 3	15	73,2	36	32	10,0

Notes: 1. Maximum sideload angle is 30°.  
2. △ = Non-standard lead time items, contact ITT Enidine.

### Clevis Mount



Catalog No./Model	(S) Stroke mm	L mm	M $+0.10/-0.00$ mm	N $+0.10/-0.00$ mm	P $+0.00/-0.10$ mm	Q mm	S mm	V mm	W mm	X mm	Mass g
△ ECO OEM 1.0M CMS	25	162,1	3,58 $+0.13/0$	6,02 $+0.13/0$	9,5 $0/-0.3$	6,4	31,8	3,2	9,0	6,4	394

Notes: 1. Maximum sideload angle is 30°.  
2. △ = Non-standard lead time items, contact ITT Enidine.



# Adjustable Series Hydraulic Shock Absorbers

## ECO OEM Small Bore Series

ECO OEM 1.15M → ECO (LR)OEM 1.25M Series

Technical Data

### Standard

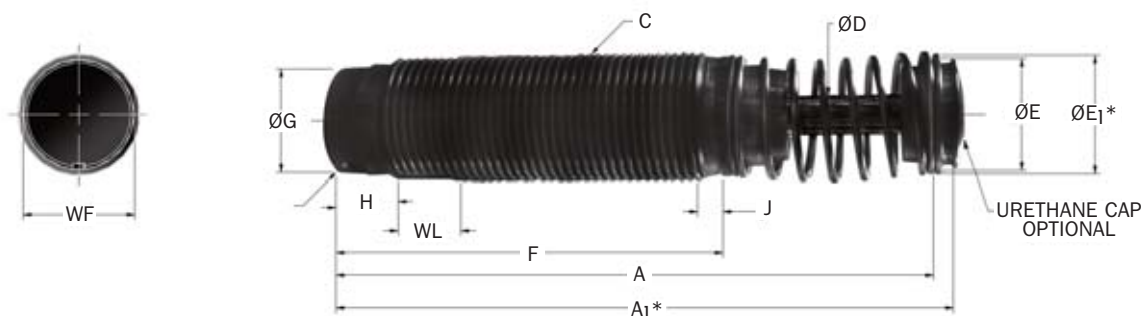

\*Note: A<sub>1</sub> and E<sub>1</sub> apply to urethane striker cap accessory.

Catalog No./Model	(S) Stroke mm	Optimal Velocity Range m/s	E <sub>T</sub> Max. Nm/c	E <sub>T</sub> C Max. Nm/hr	F <sub>p</sub> Max. Reaction Force N	Nominal Coil Spring Force		F <sub>D</sub> Max. Propelling Force N	Mass g
						Extended N	Compressed N		
△ ECO OEM 1.15M x 1	25,0	0,3-3,30	195,0	75 700	11 120	56,0	89,0	2 220	482
△ ECO (LR)OEM 1.15M x 1	25,0	0,08-2,0	195,0	75 700	11 120	56,0	89,0	3 335	482
△ ECO OEM 1.15M x 2	50,0	0,3-3,30	385,0	98 962	11 120	31,0	89,0	2 220	708
△ ECO (LR)OEM 1.15M x 2	50,0	0,08-2,0	385,0	98 962	11 120	31,0	89,0	3 335	708
ECO OEM 1.25M x 1	25,0	0,3-3,30	195,0	100 000	11 120	56,0	89,0	2 220	567
ECO (LR)OEM 1.25M x 1	25,0	0,08-2,0	195,0	100 000	11 120	56,0	89,0	3 335	567
ECO OEM 1.25M x 2	50,0	0,3-3,30	385,0	111 400	11 120	31,0	89,0	2 220	737
ECO (LR)OEM 1.25M x 2	50,0	0,08-2,0	385,0	111 400	11 120	31,0	89,0	3 335	737

Catalog No./Model	A mm	A <sub>1</sub> mm	C mm	D mm	E mm	E <sub>1</sub> mm	F mm	G mm	H mm	J mm	WF mm	WL mm
△ ECO (LR)OEM 1.15M x 1	150,0	155,5	M33 x 1,5	9,5	29,0	30,5	97,0	28,0	14,0	5,3	30,0	16,0
△ ECO (LR)OEM 1.15M x 2	217,0	222,0	M33 x 1,5	9,5	29,0	30,5	138,0	28,0	14,0	5,3	30,0	16,0
ECO (LR)OEM 1.25M x 1	150,0	155,5	M36 x 1,5	9,5	29,0	30,5	97,0	28,0	14,0	5,3	33,0	16,0
ECO (LR)OEM 1.25M x 2	217,0	222,0	M36 x 1,5	9,5	29,0	30,5	138,0	28,0	14,0	5,3	33,0	16,0

- Notes: 1. All shock absorbers will function satisfactorily at 5% of their maximum rated energy per cycle. If less than 5%, a smaller model should be specified.  
 2. For mounting accessories, see pages 25-26.  
 3. Urethane striker caps are available as accessories for models ECO OEM 1.15M x 1 to ECO OEM 1.25M x 2.  
 4. △ = Non-standard lead time items, contact ITT Enidine.

### Urethane Striker Cap (USC)

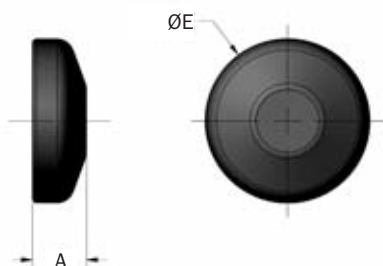

Catalog No./Model	Part Number	Model Ref	A mm	E mm	Mass g
UC 8609	C98609079	ECO (LR)OEM 1.15/1.25M	10,0	30,5	6

### Jam Nut (JN)

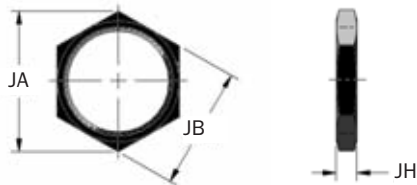

Catalog No./ Model	Part Number	Model Ref	JA mm	JB mm	JH mm	Mass g
JN M33 x 1.5	J224061035	ECO (LR)OEM 1.15M	47,3	41,0	6,4	27
JN M36 x 1.5	J224063035	ECO (LR)OEM 1.25M	47,3	41,0	6,4	27

### Stop Collar (SC)

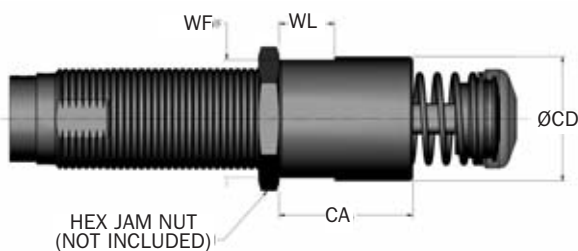

Catalog No./ Model	Part Number	Model Ref	CA mm	CD mm	WF mm	WL mm	Mass g
ΔSC M33 x 1.5	M923865058	ECO OEM 1.15M	44,5	38,1	30,0	16,0	215
ΔSC M36 x 1.5	M924063058	ECO OEM 1.25M	63,5	43,0	41,0	18,0	210
ΔSC M25 x 2 x 1.56	M924129058	HP 110 MC	50,8	38,0	32,0	15,0	215
ΔSC M25 x 1.5 x 1.56	M924129180	HP 110 MF	50,8	38,0	32,0	15,0	215

Notes: 1. \*Do not use with urethane striker cap.  
2. Δ= Non-standard lead time items, contact ITT Enidine.

### Rectangular Flange (RF)

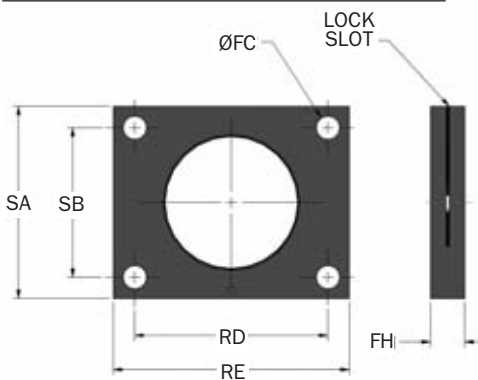

Catalog No./ Model	Part Number	Model Ref	FC mm	FH mm	RD mm	RE mm	SA mm	SB mm	Size mm	Mass g
RF M33 x 1.5	N121049141	ECO (LR)OEM 1.15M	5,5	9,5	41,3	50,8	44,5	28,6	M5	30
RF M36 x 1.5	N121293141	ECO (LR)OEM 1.25M	5,5	9,5	41,3	58,8	44,5	28,6	M5	30

# Adjustable Series Hydraulic Shock Absorbers

## ECO OEM Small Bore Series

ECO OEM 1.15M → ECO OEM 1.25M Series

Accessories

### Clevis Mount

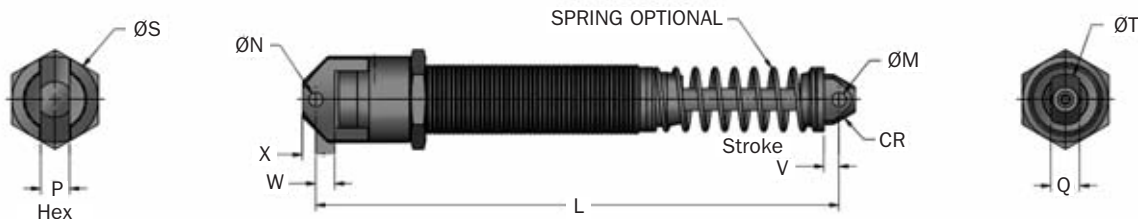

Catalog No./Model	S Stroke mm	L mm	M mm	N mm	P mm	Q mm	S mm	T mm	V mm	W mm	X mm	CR mm	Mass g
△ECO (LR)OEM 1.15 x 1 CM (S)	25	163,6	6,02 +0,13/0	6,02 +0,13/0	12,7 0/-0,3	12,7 0/-0,3	38,1	22,3	6,0	8,3	6,0	10,0	725
△ECO (LR)OEM 1.15 x 2 CM (S)	50	230,4	6,02 +0,13/0	6,02 +0,13/0	12,7 0/-0,3	12,7 0/-0,3	38,1	22,3	6,0	8,3	6,0	10,0	861
△ECO (LR)OEM 1.25 x 1 CM (S)	25	163,6	6,02 +0,13/0	6,02 +0,13/0	12,7 0/-0,3	12,7 0/-0,3	38,1	22,3	6,0	8,3	6,0	10,0	725
△ECO (LR)OEM 1.25 x 2 CM (S)	50	230,4	6,02 +0,13/0	6,02 +0,13/0	12,7 0/-0,3	12,7 0/-0,3	38,1	22,3	6,0	8,3	6,0	10,0	861

Notes: 1. "S" designates model is supplied with spring.  
2. △= Non-standard lead time items, contact ITT Enidine.

### Flange Foot Mount

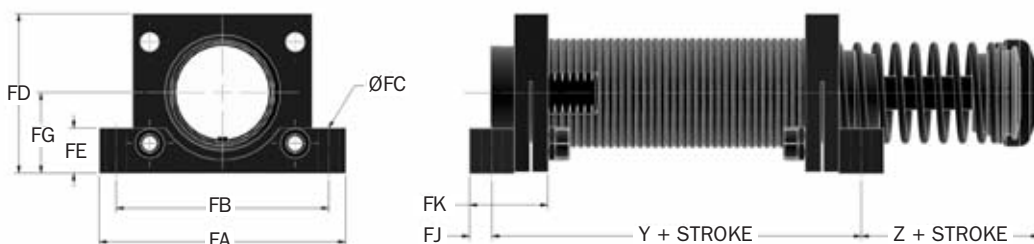

Catalog No./Model	Part Number	Model Ref	Y mm	Z mm	FA mm	FB mm	FC mm	FD mm	FE mm	FG mm	FJ mm	FK mm	Bolt Size mm	Mass g
FM M33 x 1.5	2F21049306	ECO (LR)OEM 1.15M	56,6	31,8	70,0	60,3	6,0	44,5	12,7	22,7	6,4	22,2	M5	100
FM M36 x 1.5	2F21293306	ECO (LR)OEM 1.25M	56,6	31,8	70,0	60,3	6,0	44,5	12,7	22,7	6,4	22,2	M5	100

Adjustable Series